



model T701DFP-1

Fan Coil Thermostat

2 or 4 pipe systems

7-Day Programmable Thermostat



- Remote sensor ready
- Self-prompting programming
- Auto 2-pipe changeover when used with accessory changeover sensor
- Dry contact equipped
- Backlit display
- One For All™ works with most all fan coil systems
- Electric heat ready
- Non-volatile memory
- Dual setpoint with adjustable deadband
- Keypad lockout
- Configurable display
- Display either F or C



Owner's Manual

Table Of Contents

FRONT PANEL	2
DISPLAY	3
QUICK START <i>Set the clock and go</i>	6
SELECTING THE HEAT OR COOL MODE	7
BASIC OPERATION	11
OVERRIDING THE DAILY SCHEDULE	12
PROGRAMMING <i>Occupied / Unoccupied</i>	13
ADVANCED SETUP	18
ABOUT ADVANCED FEATURES & OPERATION	24
WARRANTY	33

CAUTION Follow Installation Instructions carefully. Disconnect Power to the Heater/Air Conditioner before removing the old thermostat and installing the new thermostat.



WARNING

P/N T701DFP-1

North American Emissions Compliance

United States

This equipment has been tested and found to comply with the limits for a Class A digital device pursuant to Part 15 of the FCC Rules. These limits are designed to provide reasonable protection against harmful interference when this equipment is operated in a commercial environment. This equipment generates, uses, and can radiate radio frequency energy and, if not installed and used in accordance with the instruction manual, may cause harmful interference to radio communications. Operation of this equipment in a residential area is likely to cause harmful interference, in which case the user will be required to correct the interference at his/her own expense.

Canada

This Class (A) digital apparatus meets all the requirements of the Canadian Interference-Causing Equipment Regulations.
Cet appareil numérique de la Classe (A) respecte toutes les exigences du Règlement sur le matériel brouilleur du Canada.

Front Panel

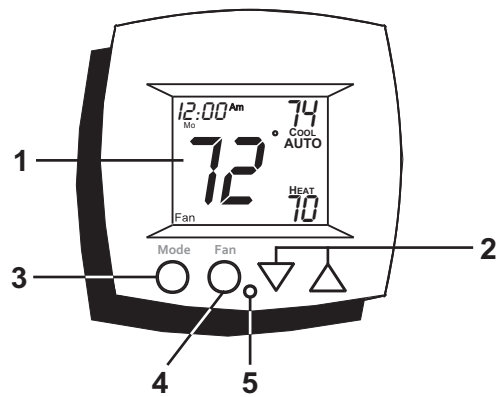

- 1 Liquid Crystal Display
with Thermoglow
- 2 Up/Down Buttons
- 3 Mode Button
- 4 Fan/Override Button
- 5 Heat or Cool Indicator
Heat = Red, Cool = Green

Display

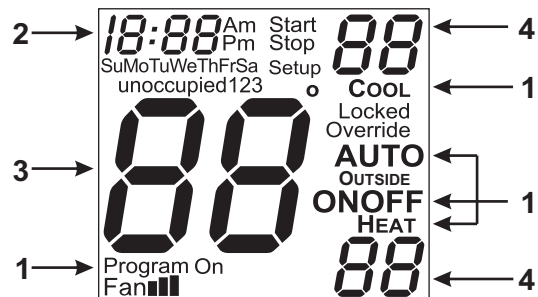

- 1 Mode Indicators - *Page 7-10*
 Selects the operational mode of the equipment.
HEAT - Indicates the heating mode.
COOL - Indicates the cooling mode.
AUTO - Indicates the system will automatically changeover between heat and cool modes as the temperature varies.
PROGRAM ON - Indicates the time period program is enabled to run.
OFF - Indicates heating and cooling are turned off.
- 2 Clock with Day of the Week - *Page 6*
 Indicates the current time and day. This clock is also used to program the time period schedules.
- 3 Room Temperature Display
 Indicates current room temperature.
- 4 Desired Set Temperature - *Page 11*
 Indicates desired room temperature(s).

Display

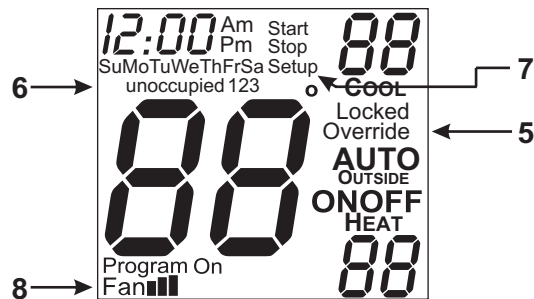

- 5 Override icon - Pages 12 & 21**
Indicates the program is currently being overridden for up to six hours.
- 6 Occupied & Unoccupied icons - Pages 13-16**
Indicates the program number: Occupied 1,2,3 or Unoccupied.
- 7 Setup icon - Pages 18-22**
Indicates the thermostat is in the advanced setup mode.
- 8 Fan ■■■ icon - Page 11**
Indicates fan operation.
Fan ■ = low speed
Fan ■■ = medium speed
Fan ■■■ = high speed
 When only the **Fan** icon is displayed, the fan is in the Auto mode and will run only when necessary to heat or cool.

Display

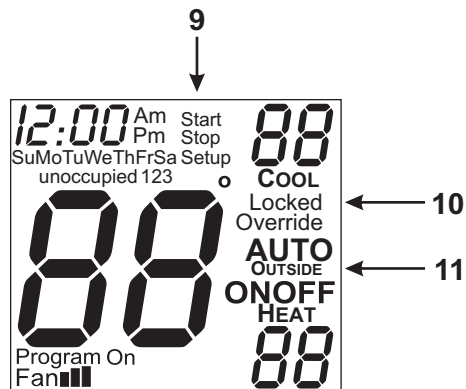

- 9 Start & Stop icons - Pages 14-16**
Appear when programming occupied time periods.
- 10 Locked icon - Page 30**
Indicates keypad has been locked.
- 11 Outside icon - Pages 21 & 31**
Indicates the temperature displayed is from the optional outside sensor.

Quick Start *Set the Clock and Go*

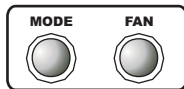

Press the MODE and FAN buttons at the same time for two seconds to enter Setup screens.

Setting the Clock

Tip: To change hours quickly, press and hold the FAN button and press the UP or DOWN button.



During Setup and Programming:
Pressing the UP or DOWN button will modify the flashing selection.

To adjust the Clock or Day, use



buttons.

Setting the Day

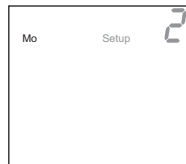

Press



Press the MODE and FAN buttons at the same time to return to normal operation.

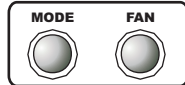

The thermostat is preprogrammed from the factory to operate a 4 pipe system without the need for further programming. To optimize the installation of this thermostat for a 2 pipe system, follow the instructions in the Advanced Setup section. *Page 19*

Selecting the Heat or Cool Mode 4-Pipe Operation

Select Mode by Pressing the MODE Button

Heating Only

The **HEAT** setting indicates the temperature that the room has to fall to before the heating source will turn on to heat the room.

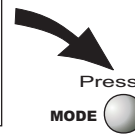
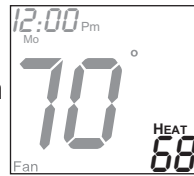

Cooling Only

The **COOL** setting indicates the temperature that the room has to rise to before the cooling source will turn on to cool the room.

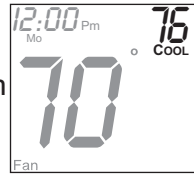

Heating or Cooling
AUTO will automatically select heat or cool based on room temperature demand.

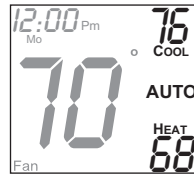

Time Schedule for Heating or Cooling
Program On will activate the stored timer operation for the heating and cooling setpoints (occupied or unoccupied periods).

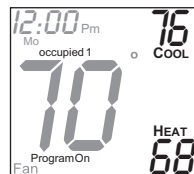

Off
OFF indicates both heating and cooling are turned off.



Selecting the Heat or Cool Mode 2-Pipe Operation

Heat Only

Step #6 = 1 in the Advanced Setup section, page 19.

Heating Only

The **HEAT** setting indicates the temperature that the room has to fall to before the heating source will turn on to heat the room.

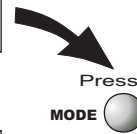
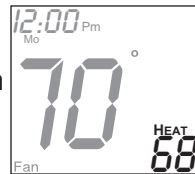

Time Schedule for Heating or Cooling

Program On will activate the stored timer operation for the heating and cooling setpoints (occupied or unoccupied periods).

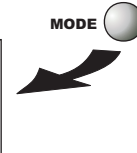
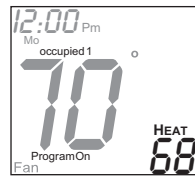

Off

OFF indicates both heating and cooling are turned off.

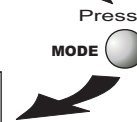

Selecting the Heat or Cool Mode 2-Pipe Operation

Cool Only

Step #6 = 2 in the Advanced Setup section, page 19.

Cooling Only

The **COOL** setting indicates the temperature that the room has to rise to before the cooling source will turn on to cool the room.

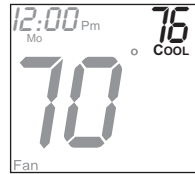

Press

MODE

Time Schedule for Heating or Cooling

Program On will activate the stored timer operation for the heating and cooling setpoints (occupied or unoccupied periods).



Press

MODE

Off

OFF indicates both heating and cooling are turned off.

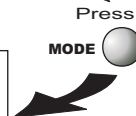

Press

MODE

Selecting the Heat or Cool Mode 2-Pipe Operation

Heating and/or Cooling

Step #6 = 3 in Advanced Setup (page 19), and a changeover sensor is used.

Step #6 = 4 or 5 in Advanced Setup (page 19).

Operation is the same as a 4-pipe system (page 7).

HEAT indicates the temperature that the room has to fall to before the heating source energizes. If the water supply is cold, this screen and heating would be locked out.

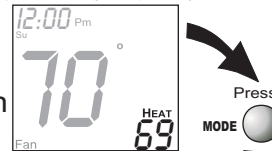

COOL indicates the temperature that the room has to rise to before the cooling source energizes. If the water supply is hot, this screen and cooling would be locked out.

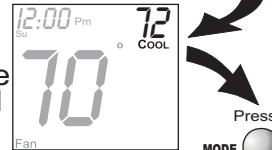

If step #6 = 3, this screen will not appear.

AUTO will automatically select heat or cool based on the room temperature demand.

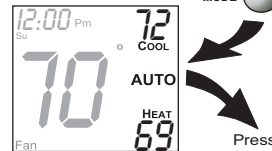

If step #6 = 3, only heat or cool will appear.

Program On will activate the stored timer operation for the heating and cooling setpoints.

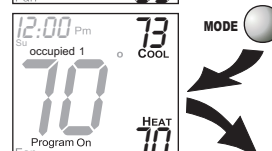

OFF indicates both heating and cooling are turned off.

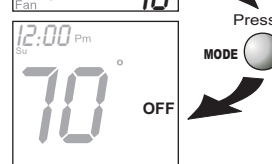

Note: If the water temperature is changed during the year, the thermostat will then automatically lock out the incorrect mode. Page 10

Basic Operation

Selecting Your Desired Temperature (adjusting the setpoints)

AUTO OR PROGRAM MODE

Pressing the UP or DOWN button in Auto or Program mode will adjust **both** the heat and cool set temperatures simultaneously.

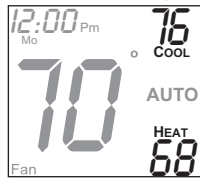

Adjust the desired set temperature with the



buttons.

Fan Operation

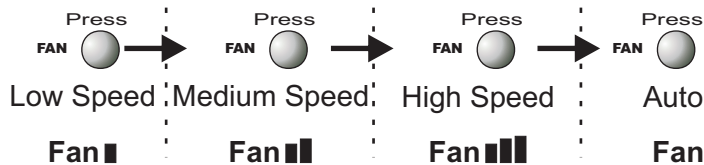
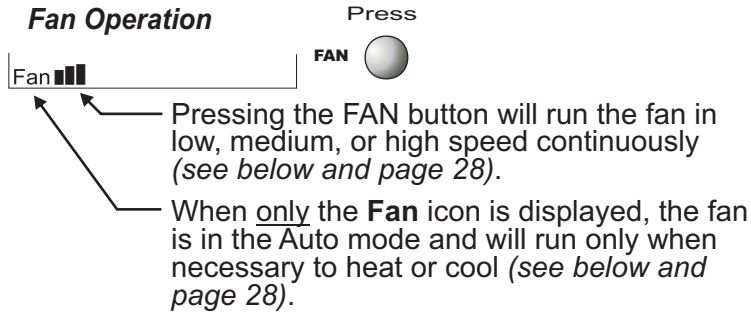

Note: If the thermostat is placed in the Off mode, the fan will de-energize (see page 7).

Basic Operation

Overriding the Daily Schedule

Pressing and holding the FAN button for 5 seconds may be used to interrupt the normal time schedule programming of the thermostat. The override feature may only be used when the thermostat is running the time schedule, in Program On mode.

Unoccupied Operation - During programmed, unoccupied periods pressing and holding the FAN button for 5 seconds will temporarily force the thermostat into Occupied 1 comfort settings for one to six hours (*step #13, page 21*). The Override icon will be illuminated during this time. If you press and hold the FAN button while the thermostat is currently overriding the daily schedule, this will reset the timer, returning the thermostat to the correct time period program for the day.

Occupied Operation - Pressing and holding the FAN button for 5 seconds during a programmed Occupied time period will have no effect.

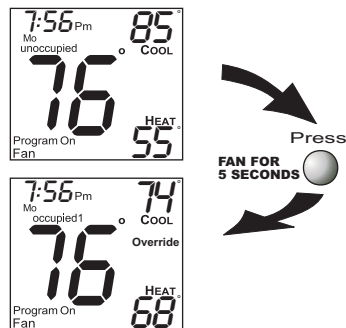

Programming Occupied & Unoccupied Periods

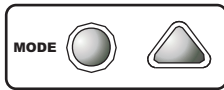

Press the MODE button. While holding MODE, press the UP button for two seconds to enter time period programming.

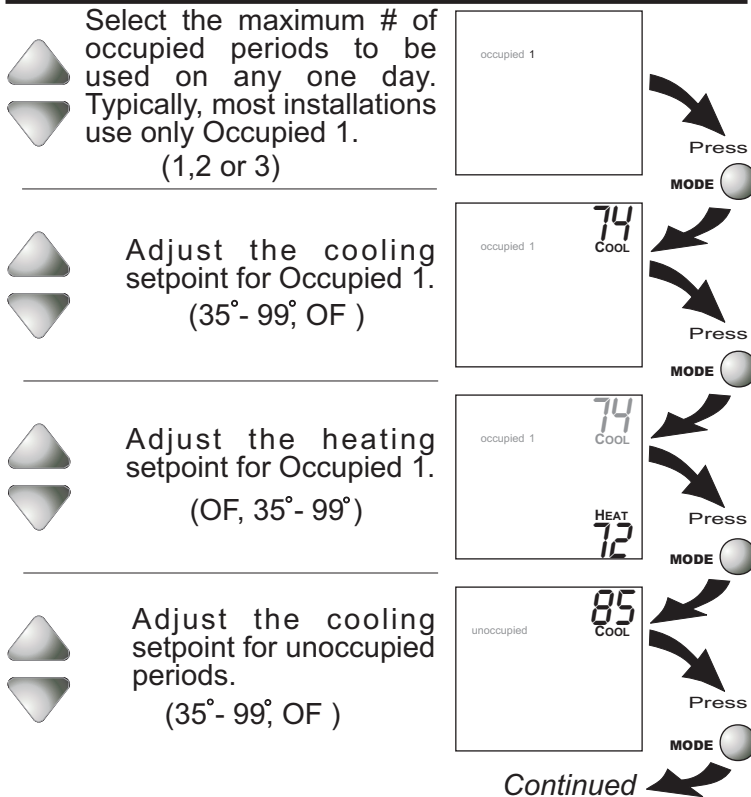

Programming Occupied & Unoccupied Periods

	<p>Adjust the heating set-point for Unoccupied periods. (OF, 35°- 99°)</p>		<p>Press MODE</p>
	<p>Select day of the week for Occupied 1. (Mo - Su)</p>		<p>Press MODE</p>
	<p>Adjust the start time for Occupied 1.</p>		<p>Press MODE</p>
	<p>Adjust the stop time for Occupied 1.</p>		<p>Press MODE</p>
<p>On Off</p>	<p>Select Occupied 1 to run on this day (On), or not to run on this day (Off).</p>		<p>Press MODE</p>

Programming Occupied & Unoccupied Periods

The copy command becomes available after the maximum # of occupied periods are programmed in a day. This example uses 1 as the maximum occupied periods ever programmed in one day.

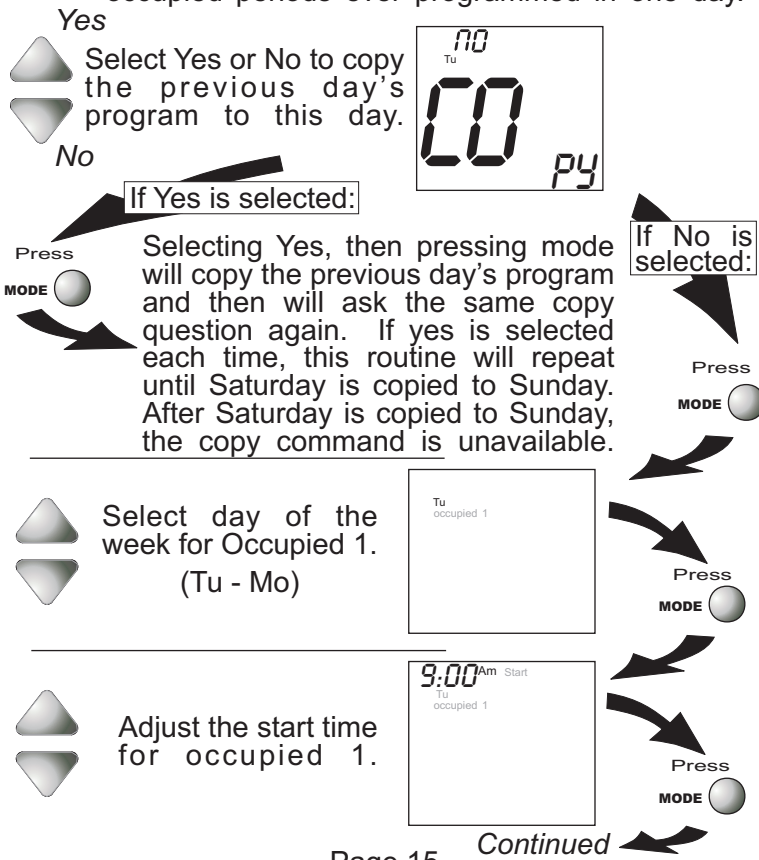

Programming Occupied & Unoccupied Periods

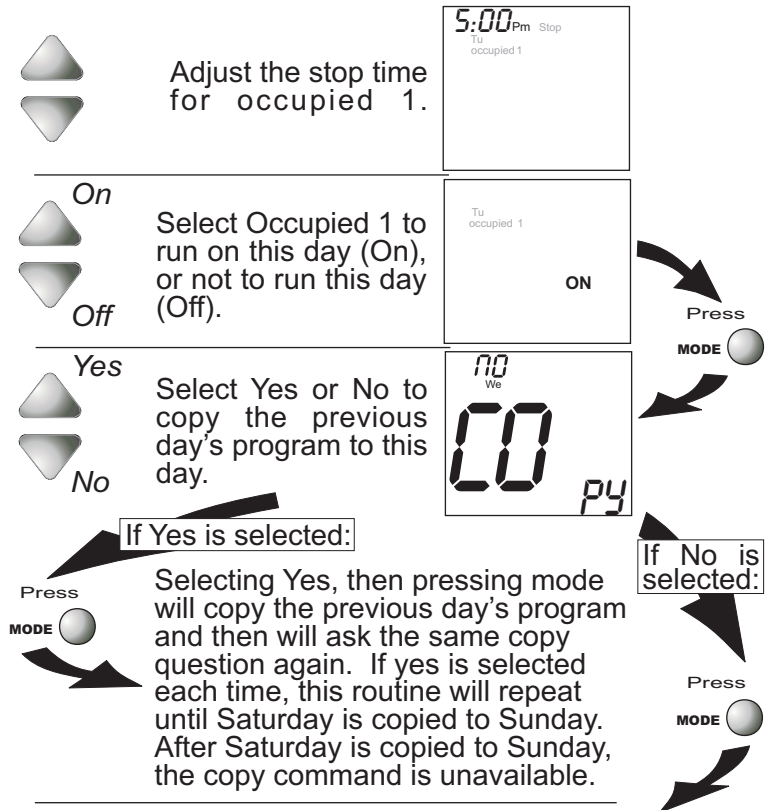

If no is selected, as in previous steps flashing prompts for input will appear for start and stop times for Occupied 1. If more than one occupied period was selected on page 13, then cool/heat setpoints, and start/stop times for additional occupied periods will be prompted.

Programming Occupied & Unoccupied Periods

PROGRAMMING NOTES

*** You will be prompted to enter both heat and cool setpoints even if the thermostat is configured for heat only, or cool only.**

* If only 1 Occupied period is selected, the Occupied 2 & 3 steps will be skipped. Further, if only 2 occupieds are selected, the Occupied 3 steps will be skipped.

* Heat & Cool setpoints for Occupied 1 are the same for each day. Heat & Cool setpoints for Occupied 2 & 3 can be adjusted differently for each day, if desired.

* **If the start time is set for later than the stop time**, the program will run from the start time to midnight and from midnight to the stop time on the same day. *For example: 9:00pm start, 8:00am stop, on MTWTF. This program will run from 12:00am MTWTF to 8:00am MTWTF and again from 9:00pm MTWTF to 12:00pm MTWTF.*

* The Unoccupied settings take effect at all times when: (1) the program is on **and** (2) the current time is outside a preset occupied period. For this reason start and stop times aren't necessary for unoccupied.

* If the **same** start and stop times are programmed in for an occupied period, then it will run 24 hours.

* If one occupied period starts and stops within another occupied period, the lower occupied # has priority. *For example: If Occupied 3 is programmed to be "on" 24 hours, and Occupied 2 is programmed to run that day, then Occupied 2 settings will take over from Occupied 3 between Occupied 2 start and stop times.*

* When the time period programming for Unoccupied is in the Override mode (see page 12), the Heat & Cool setpoints for Occupied 1 are used.

Advanced Setup

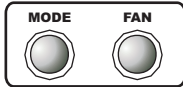

Press the MODE and FAN buttons at the same time for 10 seconds to enter Advanced Setup screens.

NOTE: Each step # is located at the top right corner of the display for easy reference.

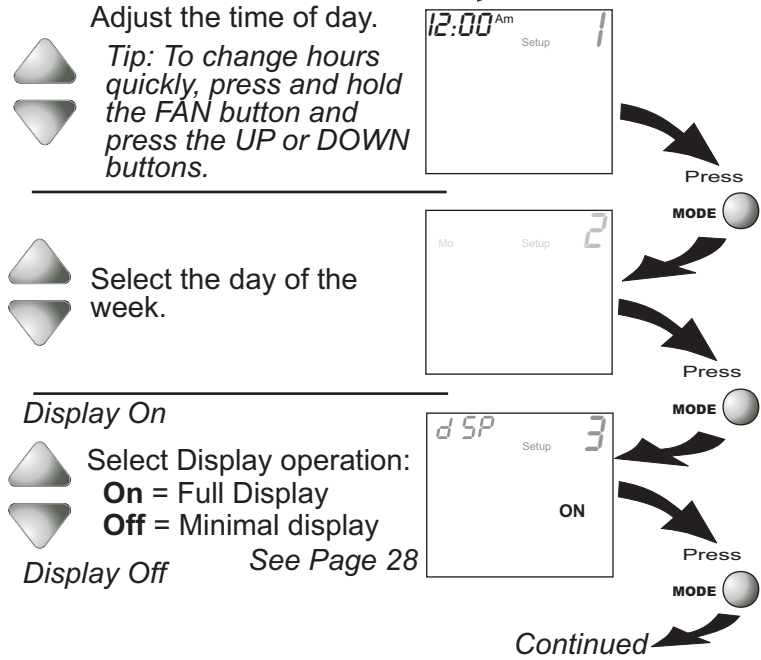

Advanced Setup



Select Display operation:

- 1 = Single Setpoint
- 2 = Dual Setpoint

See Page 32



Note: When Single Setpoint is selected, the heating or cooling setpoint will always be displayed. To display the room temperature, press and hold the MODE button for two seconds. The degree icon will blink when the large number is displaying room temperature and will remain solid when displaying the heating or cooling setpoint.

Press
MODE



Select fan coil system type:

- 2 = 2-pipe fan coil
- 4 = 4-pipe fan coil

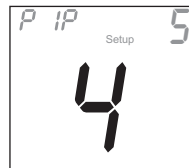

Step #6 only appears if step #5 = 2.

2 PIPE SYSTEM OPERATION

- 1= Heat only system
- 2= Cool only system
- 3= Heat/Cool Auto changeover
- 4= Heat/Cool Aux Electric heat, Lockout Electric Heat when Hot Water is available
- 5= Heat/Cool total electric heat, **no** Hot Water, **only** Electric Heat.

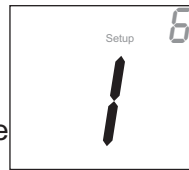



Press
MODE

Press
MODE

Continued



Note: #3 & #4 require accessory changeover sensor Page 19

Advanced Setup

 *On*
 *Off*



Select operation when fan is in the Auto mode:
On = continuous low speed fan
Off = only energize during a heating or cooling cycle.

See Page 28, Note #2





Adjust the deadband for the 1st stage.
 (1° - 6°)

See Page 25





Adjust the minimum **difference** between cooling & heating setpoints.
 (0° - 6°)

 *On*
 *Off*

Select backlight operation:
On - Light continuously
Off - Light for 8 seconds after a button press

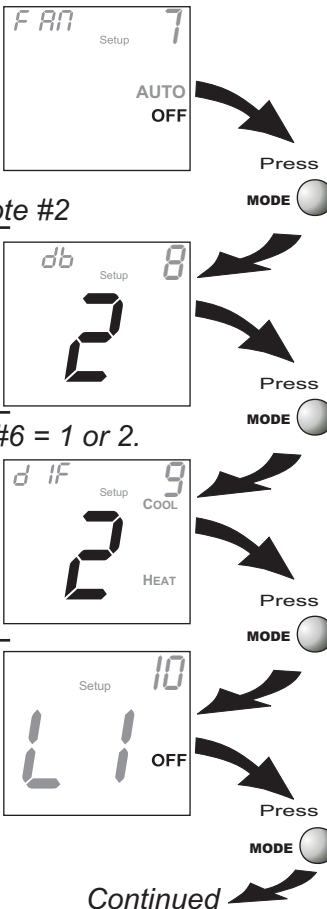
Continued



Advanced Setup

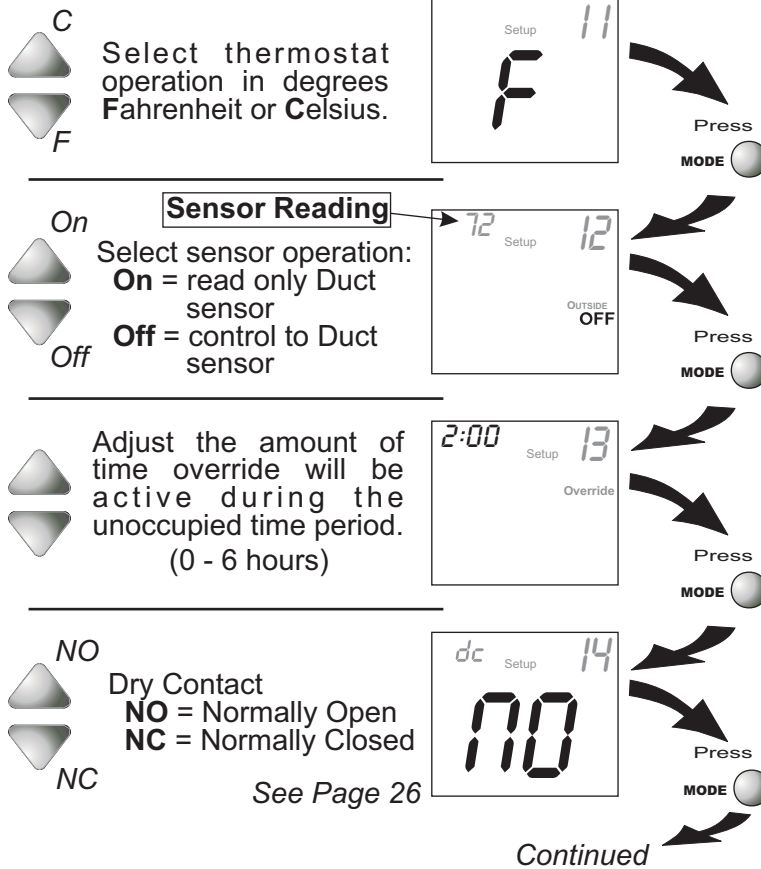

Advanced Setup

Occupied



Unoccupied



Select Dry Contact operation:

Occupied = the thermostat will enter the Occupied mode when the Dry Contact is closed.

Unoccupied = the thermostat will enter the Unoccupied mode when the Dry Contact is closed.



Step #16 only appears if step #15 = Unoccupied. Press

Unoccupied Setpoints



Off

Select Dry Contact Unoccupied operation:

Unoccupied = when the Dry Contact is closed, the thermostat will control to the Unoccupied setpoints.

Off = when the Dry Contact is closed, the thermostat will turn off.

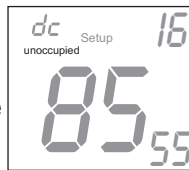

After programming is complete, press the MODE and FAN buttons at the same time for two seconds to leave the Setup screens. If no buttons are pressed, the display will leave the setup screens after 30 seconds.

Advanced Setup

Advanced Setup Table

Step #	Description	Range	Factory Default
1	Time of Day	24 hour	12:00 am
2	Day of the Week	Mo - Su	Mo
3	Display Blanking	On / Off	On
4	Single or Dual Setpoint	1 / 2	2
5	2- or 4-Pipe System	2 / 4	4
6	2-Pipe System Operation	1 - 5	1
7	Fan Auto Operation	On / Off	Off
8	Deadband/Temp. Swing 1st Stage	1° - 6°	2°
9	Minimum Heat/Cool Differential	0° - 6°	2°
10	Thermoglow Backlight	On / Off	Off
11	Fahrenheit or Celsius	F / C	F
12	Read Only Duct Sensor?	On / Off	Off
13	Override Timer Length	0 - 6 hours	2 hours
14	Dry Contact Polarity	NO / NC	NO
15	Dry Contact Operation	Occupied / Unoccupied	Occupied
16	Dry Contact Setpoints	Unoccupied / Off	Unoccupied

About Advanced Features & Operation

- * CALIBRATION - Under normal circumstances it will not be necessary to adjust the calibration of the temperature sensor. If calibration is required, please contact a trained HVAC technician to correctly perform the following procedure.

- 1**

MODE Place the thermostat in the OFF mode.



- 2**

MODE Press and hold the MODE button. While holding the MODE button, press and hold the DOWN button for 5 seconds. All icons will appear on the display.



- 3**

MODE Press the MODE button once. The thermostat temperature will be displayed and may be calibrated using the UP or DOWN button.

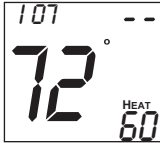

- 4**

MODE After calibration is complete, press the MODE button **once** to save your changes and return to normal operation.



- * CLOCK BACKUP - In the event of a power loss, the thermostat's internal clock will continue to keep proper time for a minimum of 48 hours without external power or batteries.

About Advanced Features & Operation

* **DEADBAND OPERATION** - Controls one Heat and one Cool stage with a three speed fan (see below).

The **low speed fan** for heat or cool is turned on when: The temperature spread from the setpoint is equal to or greater than: *the setpoint plus the 1st stage deadband (step #8, page 20)*. This 1st stage deadband is adjustable from 1-6 degrees and the default is two degrees.

The **medium speed fan** for heat or cool is turned on when: The temperature spread from the setpoint is equal to or greater than: *the setpoint plus the 1st stage deadband (step #8, page 20), plus the 2nd stage deadband*. This 2nd stage deadband is fixed at one degree and is not adjustable.

The **high speed fan** for heat or cool is turned on when: The temperature spread from the setpoint is equal to or greater than: *the setpoint plus the 1st stage deadband (step #8, page 20), plus the 2nd stage deadband, plus the 3rd stage deadband*. This 3rd stage deadband is fixed at one degree and is not adjustable.

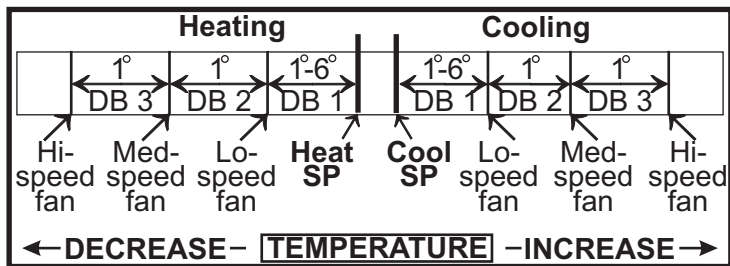

The above figure assumes the minimum on time for the prior stage has been met to allow the next stage to turn on, once the deadbands have been exceeded.

About Advanced Features & Operation

- ✿ **DRY CONTACT SWITCH** - This feature allows an external device such as a Central Time Clock, Occupancy Sensor, or a Telephone activated device to force one or more thermostats into Occupied 1 or Unoccupied (steps #14 and 15, page 21-22).

When the CK1 and R terminals are shorted together, and the thermostat is programmed for Occupied operation (step #15, page 22) the thermostat will be forced into Occupied 1 setpoints and the Occupied 1 icon will blink.

Note: The thermostat must be in Program On mode for this feature to have any effect.

Important Note: For control of multiple thermostats by one source, refer to 'Potential Phasing Problems' on page 32.

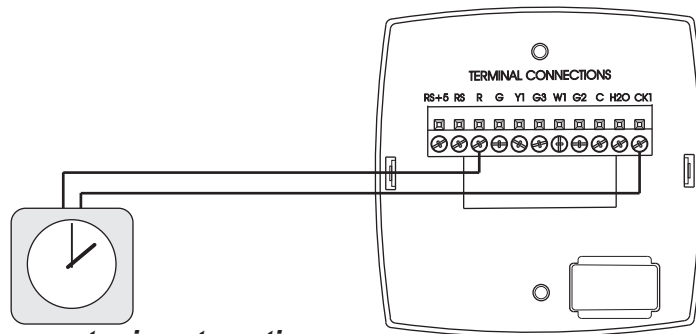

Connect wires to a time clock or other device to force the thermostat into Occupied 1 or Unoccupied.

About Advanced Features & Operation



- * **FACTORY DEFAULTS** - If, for any reason, you desire to return all the stored settings back to the factory default settings, follow the instructions below.

WARNING: This will reset all Time Period and Advanced Programming to the default settings. Any information entered prior to this reset will be permanently lost.

- 1**

MODE  Place the thermostat in the OFF mode.



- 2**

MODE   Press and hold the MODE button. While holding the MODE button, press and hold the DOWN button for 5 seconds. All icons will appear on the display.

- 3**

FAN  After all of the icons appear, release the MODE and DOWN buttons. Then press and hold the FAN button for 5 seconds.

- 4**

MODE  After the letters **Fd** appear on the display (Factory Default), release the FAN button. Press the MODE button **twice** to return to normal operation.



About Advanced Features & Operation

- * FAN OPERATION - Fan operation is available in four different modes:

Fan: When only the fan icon is displayed, this indicates that the fan is in the Auto mode, will only energize during a heating or cooling cycle, and will modulate fan speeds based on temperature demand (see page 25).

Fan■, Fan■■, or Fan■■■: Pressing the FAN button will cause the low, medium, or high speed fan icon to appear (see page 11), indicating that the fan will run continuously. The fan will de-energize if the thermostat is placed in the Off mode or an unoccupied time period (see page 26).

Notes:

1) *If a Duct sensor is connected to this thermostat, then the fan should be programmed for continuous operation (step #7, page 20). This will provide airflow over the Duct sensor and provide more accurate temperature readings.*

2) *If the fan is programmed for continuous operation (step #7, page 20), the low speed fan will run continuously when the fan is in the Auto mode and during occupied time periods, but will de-energize if the thermostat is placed in the Off mode.*

- * MINIMAL DISPLAY - When the thermostat is programmed for a minimal display (step #3, page 18), only the time of day will appear. When a button is pressed the full, normal display will appear for 10 seconds.

About Advanced Features & Operation

- ✿ ENERGY SAVING SMART FAN - This feature automatically de-energizes the fan during an Unoccupied time period, except when necessary to heat or cool (see page 28).

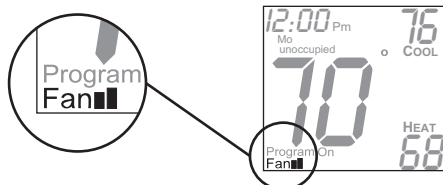

Note: The fan will not de-energize during an Unoccupied time period if it has been programmed for continuous operation (step #7, page 20).

- ✿ HEAT/COOL DIFFERENTIAL - The Heat and Cool setpoints will not be allowed to come any closer to each other than the value set in Advanced Setup step #9, on page 20. This minimum difference is enforced during Auto-changeover and Program On operation.

Note: To increase the spread between the heating and cooling setpoints in the Auto-changeover mode press the MODE button until only the heat setpoint is displayed; adjust to the desired setpoint. Press the MODE button until only the cool setpoint is displayed; adjust to the desired setpoint. Press the MODE button again to enter the Auto-changeover mode where both the heat and cool setpoints are displayed.

About Advanced Features & Operation

- * **KEYPAD LOCKOUT** - To prevent unauthorized use of the thermostat, the front panel buttons may be disabled. To disable, or 'lock' the keypad, press and hold the MODE button. While holding the MODE button, press the UP and DOWN buttons together. The LOCKED icon will appear on the display, then release the buttons.

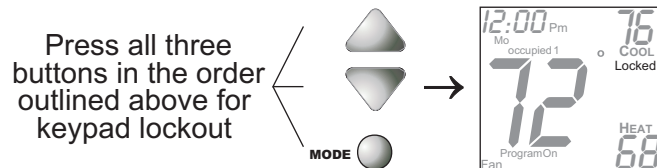

To **unlock** the keypad, press and hold the MODE button. While holding the MODE button, press the UP and DOWN buttons together. The LOCKED icon will disappear from the display, then release the buttons.

- * **LOCKING COVER w/Tamper Proof Screws**

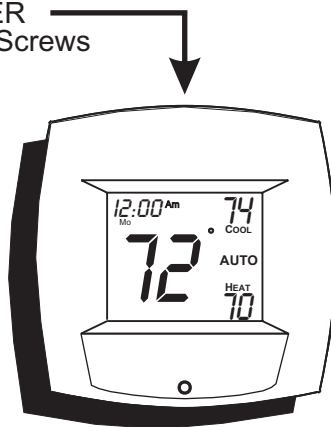

About Advanced Features & Operation

- ✿ **OUTSIDE SENSOR** - To view an Outside Sensor (*step #12, page 21*), enter the Advanced Setup by pressing and holding the MODE button. While holding MODE, press the FAN button for 5 seconds to enter Setup screens. Advance to setup step #12 by repeatedly pressing the MODE button. If an optional outside sensor is connected, the outside temperature will appear in the clock display.
- ✿ **DUCT SENSOR (P/N SEN-700-1)** - The thermostat is programmed from the factory to automatically recognize when a Duct Sensor is connected (*step #12, page 21*).

The Duct Sensor measures indoor air temperature and sends this information to the thermostat; it measures temperature with a range of 32° to 99° F.

The Duct Sensor should be connected to the thermostat using solid conductor CAT 5, CAT 5e, or CAT 6 type network communication cable. This is an unshielded cable with four twisted pairs of 24 gauge solid wire; *DO NOT use stranded cable*. The cable length should not exceed 250 feet. If less than 75 feet of cable is required to connect the thermostat to the Duct Sensor, a two conductor thermostat cable (16-24 gauge) may be used; this cable is NOT suitable for any length greater than 75 feet.

IMPORTANT: Do not use shielded wire. Do not run sensor wiring in the same conduit as the 24VAC thermostat wiring. Electrical interference may cause the sensor to give incorrect temperature readings. See the *Duct Sensor instructions* for further details.

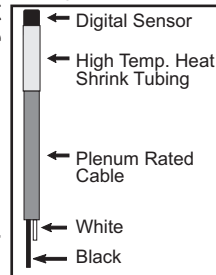

About Advanced Features & Operation

- ✿ **SINGLE SETPOINT BEHAVIOR** - When configured for *Single Setpoint* operation (*step #4, page 19*), the degree icon will blink when the large number is displaying room temperature and will remain solid when displaying the heating or cooling setpoint. In the Auto and Program On modes the deadband is enforced both above and below the setpoint. To avoid short cycling, a deadband of at least two degrees is recommended (*step #8, page 20*). To display the room temperature press and hold the MODE button for two seconds. Release the MODE button to return to the normal display.

CAUTION Auxiliary Input Control and Multiple HVAC Control Potential Phasing Problems WARNING

When using the auxiliary input (CK1 & R) or controlling multiple HVAC units with a single thermostat, it is possible to encounter transformer phasing problems that will interfere with thermostat operation. Connecting transformers that are not phased correctly may result in a direct short, which could damage transformers and/or the thermostat. Phasing problems are likely if the units share a common ground with secondary grounded transformers.

SOLUTION: If possible, phase all HVAC units together. If phasing is impractical, isolation relays may be used to isolate the transformers. To isolate the auxiliary input, use a separate transformer for the auxiliary control device, usually a time clock. Connect the device to an isolation relay coil. Connect one set of isolated contacts to each thermostat at **CK1** and **R**. See diagram A.

Diagram A- Auxiliary Control

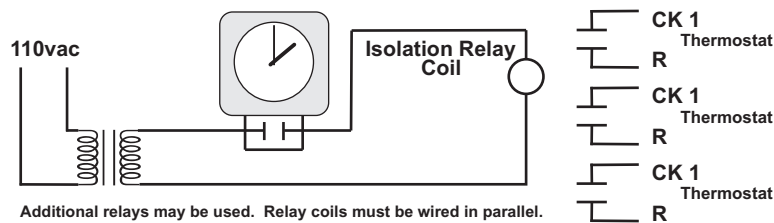

Additional relays may be used. Relay coils must be wired in parallel.



P/N 88-824 Rev. 1H

P.O. Box 423 • Milwaukee, WI 53201-0423 • 414.524.7349 [phone] • 414.524.5043 [fax] • www.jci.com
©2010 Johnson Controls Inc (JCI).
